

# CX12 S4 1000X520 GEL

SMALL SIZE, GREAT MANOEUVRABILITY



## CX12-CX14

The CX electric pallet trucks are available in different versions equipped with MOSFET technology. They are suitable for carrying loads on smooth or paved surfaces. Its small size and turning radius make it the ideal tool to work with in confined spaces, such as lorries or narrow aisles.

## MANOEUVRABILITY

Thanks to the B1 width, which is equal to the fork gauge, and the L2 measurement of 360 mm, the CX12 electronic pallet truck is the ideal tool for the handling of pallets on lorries, in supermarket aisles and any application where space is limited. This machine is the best configuration in its category thanks to the frame width, in-service weight and turning radius, thus guaranteeing great manoeuvrability and compactness.



## STEERING WHEEL AND CONTROLS

- Ergonomic tiller
- Luminous indicator for battery state control.
- Butterfly valves for traction control.
- Safety pushbutton with warning buzzer.
- Forks way up/down control positioned on both sides of the handle (only on CX14).
- Hour counter in the Plus and Gel versions (only on CX14).
- "Tortoise" pushbutton for slow motion, which allows for the carrying out of operations with the tiller in vertical position.



## PLUS BATTERIES

The Plus versions are equipped with semitraction batteries that guarantee greater autonomy and an operative life that allows for up to 5 times higher a number of charge life cycles.

Thanks to the design of its guard, access to batteries is easy and rapid; this model also optimally combines size, power and low running cost also due to the integrated batteries and battery charger.



## STABILIZERS

Two stabilizing wheels enable movement even on more difficult surfaces thus guaranteeing maximum stability in any condition of use.



## Descriere

1.1 Producător			LIFTER
Stivuator			Electric
1.3 Comandă			Electric
1.4 Poziție operare			Pedestru
1.5 Capacitate maximă	Q	Kg	1200
1.6 Distanța la centrul de aplicare al sarcinii	c	mm	500
1.8 Sarcina de la osie la capătul furcilor	x	mm	736
1.9 Ampatament	y	mm	969

## Greutăți

2.1 Greutate de operare (acumulator inclus)		Kg	159
2.2 Sarcină osie, încărcare pe spate		Kg	940
2.2 Sarcină osie, încărcare pe față		Kg	419
2.3 Sarcină osie, liber față		Kg	127
2.3 Sarcină osie, liber spate		Kg	32

## Cauciucuri/Șasiuri

3.1 Cauciucuri: roți direcție			RUBBER
3.1 Cauciucuri: roți stabilizatoare - Față			POLY.I.
3.1 Cauciucuri: transportoare cu role			NYLON
3.2 Mărime cauciuc: roți direcție - Lățime		mm	50
3.2 Mărime cauciuc: roți direcție - Diametru		mm	186
3.3 Mărime cauciuc: transportoare cu role - Diametru		mm	82
3.3 Mărime cauciuc: transportoare cu role - Lățime		mm	60
3.4 Mărime cauciuc: roți stabilizatoare față - Diametru		mm	75
3.4 Mărime cauciuc: roți stabilizatoare față - Lățime		mm	32
3.5 Dimensiune cauciuc: roti spate		nr	4
3.5 Dimensiune cauciuc: roti fata		nr	1x
3.6 Ecartament, față	b10	mm	369
3.7 Ecartament, spate	b11	mm	371

## Dimensiuni

4.4 Înălțime stivuator	h3	mm	115
4.9 Height of tiller in drive position min	h14	mm	885
4.9 Înălțime manetă în poziția de deplasare, max	h14	mm	1345
4.15 Înălțime, coborât	h13	mm	85
4.19 Lungime globală	l1	mm	1360
4.20 Distanța până la suprafața frontală a furcilor	l2	mm	360
4.21 Lățime globală	b1	mm	520
4.22 Dimensiuni furcă - grosime	s	mm	55
4.22 Dimensiuni furcă - Lățime	e	mm	150
4.22 Dimensiuni furcă - Lungime	l	mm	1000
4.25 Distanța între furci	b5	mm	520
4.32 Gardă la sol și mijloc ampatament	m2	mm	30
4.34 Lățime culoar	Ast	mm	1582
4.35 Rază de virare	Wa	mm	1118

**Performante**

5.1 Viteză de deplasare cu incarcare	Km/h	4.5
5.1 Viteză de deplasare fără incarcare	Km/h	4.7
5.2 Viteză de ridicare, încărcat	m/s	0.02
5.2 Viteză de ridicare, descărcat	m/s	0.03
5.3 Viteză de coborâre, încărcat	m/s	0.04
5.3 Viteză de coborâre, descărcat	m/s	0.04
5.8 Tracțiune maximă în pantă (cu incarcare)	%	5
5.8 Tracțiune maximă în pantă (fără incarcare)	%	10
5.10 Frână de serviciu		Electric

**Motoare electrice**

6.1 Putere motor comandă	kW	0.35
6.2 Putere motor stivuitor	kW	0.4
Tip acumulator	Type	Tracțiune (C5)
6.4 Tensiune acumulator	V	24
6.4 Capacitate acumulator, Min	Ah	40
6.4 Capacitate acumulator, Max	Ah	40
6.5 Greutate acumulator, min	Kg	25
6.5 Greutate acumulator, max	Kg	40
6.6 Consum de energie în ciclu VDI	kWh/h	0.28
8.4 Nivel sonor la nivelul urechii șoferului	dB(A)	67

\*Integrated battery and battery charger

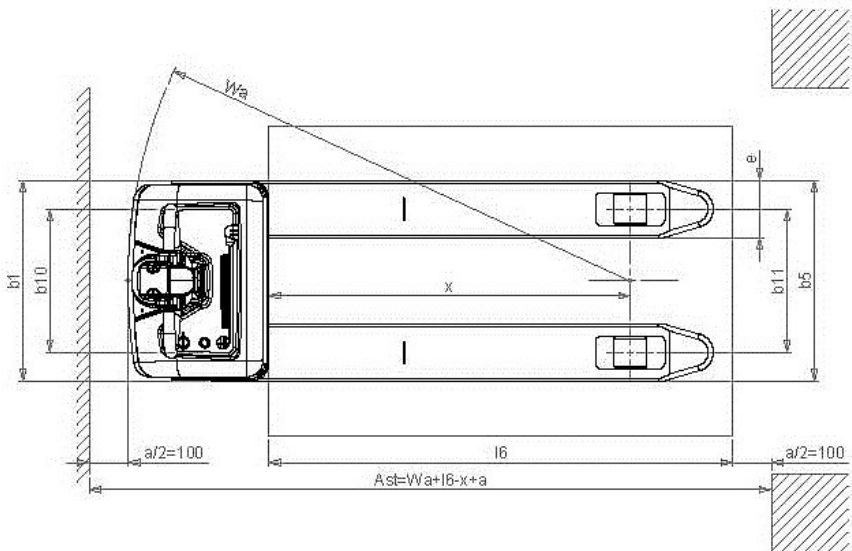
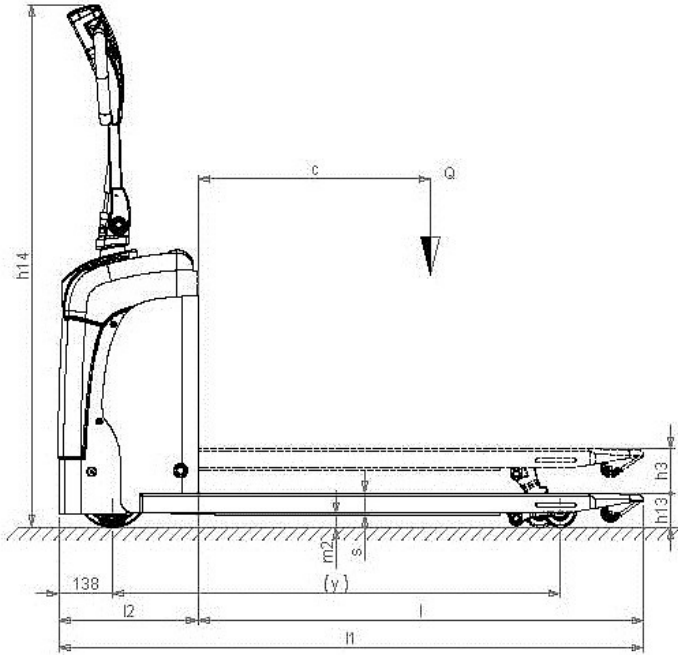

The information is aligned with the Data file at the time of download. Printed on 01/10/2017 (ID 467)

©2017 | PR INDUSTRIAL s.r.l. | All rights reserved | Image shown may not reflect actual package. Specifications subject to change without notice

